

RadiaLED® Rapid Pro Range

Installation instructions for RadiaLED® Rapid Pro bulkhead



WARNINGS AND CAUTIONS

- To avoid electric shock ⚠ or serious injury or property damage, isolate power before installing, removing or servicing the product
- It is recommended that this product is installed by an electrician or a competent person with sufficient experience to install this product
- To be installed in accordance with the local current wiring regulations and standards
- Any broken or damaged parts should be replaced as soon as possible
- JCC will not accept responsibility for claims arising from sub-standard installations; which will void the warranty
- Ensure that you have the tools and accessories required to complete the installation correctly
- This luminaire is suitable for indoor use or exterior use, wall or ceiling mounting
- Do not install in areas that are near to continual running water
- Do not carry out insulation tests with this product connected to the circuit

INSTALLATION INSTRUCTIONS

ENGLISH

Mains supply Input : 220-240V~ 50/60Hz Class II ☐

- Isolate power supply.
- Ensure that the body is installed in the correct orientation if wall mounted as indicated by the "THIS WAY UP" arrow inside the body(see fig.1.)This will ensure that the LED module is suspended correctly with security strap below the body when installing.(see fig.6.)
- Mains input cable entry options are in the centre of the body(see fig.2.)or 4 conduit entry point options on the side of the body(see fig.3.), you will need to drill a Ø20mm hole and use the supplied grommet(s) to maintain the IP rating of the fitting. It is recommended to drill this from the back of the body.
- To secure the body to the mounting surface you will also need to drill pilot holes of Ø4-6mm to accommodate the fixing screws. There are two mounting options: 4 x direct to the mounting surface or by using the option for BESA mounting in the centre of the body. The counter sunk molded fixing points are around the outside edge of the interior of the body adjacent to four conduit side entry points(see fig.3.) and in the centre for BESA mounting(see fig.2.)
- Connect the mains input into the terminal block in the body(see fig.4.) Terminal block is loop-in /loop-out to allow for continuous wiring.

Wattage Selectable	3 CCT Selectable	Lumens	Standard operation mode	Battery charging operation mode (initial charge 24hrs)	Parasitic Power
8/12W	3000K/4000K/5700K	Up to 1300	8W	11W(8W+3W)	1W
12/16/20W	3000K/4000K/5700K	Up to 2430	12W	15W(12W+3W)	1W
			16W	19W(16W+3W)	1W
			20W	23W(20W+3W)	1W

L¹ = Unswitched Live
L = Switched Live
E = Earth provision only
N = Neutral

- Before turning on mains supply, select preferred Wattage and CCT using the switches on the gear tray as indicated in Fig.7.a.(8/12W) and Fig.7.b.(12/16/20W)
- For emergency versions, the batteries are enclosed in the inverter and are already connected so do not require commissioning.
- Once you have completed all of the connections, fit LED tray into the body by aligning the 4 slots and press into place until clipped in.
- To fit the diffuser align the 4 captive screws in the diffuser with the holes in the body which have corresponding lugs for alignment(see fig.5.) Ensure that the screws are not over-tightened as this could damage the gasket and effect the IP rating.
- Turn on mains supply and test operation(allow 24hrs for the battery to charge before testing emergency operation)

Fig.1.

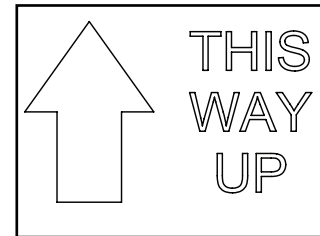

Fig.2.

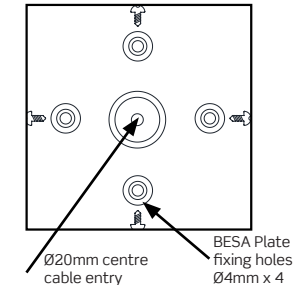

Fig.3.

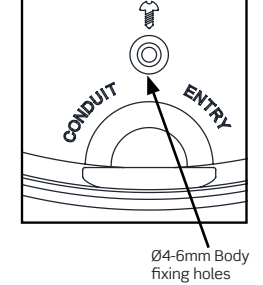
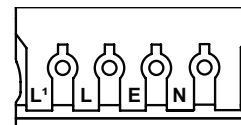

Fig.4.



L¹ = Unswitched live
 L = Switched Live
 E = Earth Provision only
 N = Neutral

Fig.5.

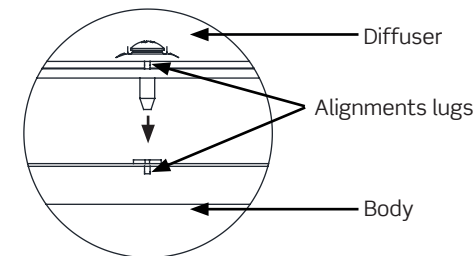

Fig.6.



Fig.7.a.

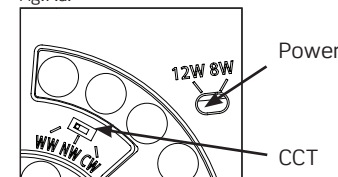
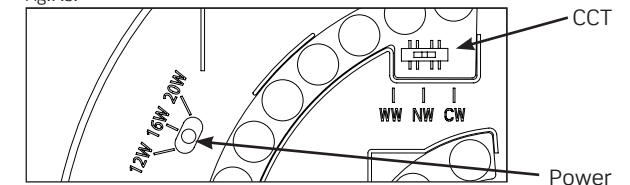



Fig.7.b.



Microwave on/off and dim version operation and settings

Detection Area

I: Up to 3m
 II: Up to 2.25m
 III: Up to 1.5m
 VI: Up to 0.75m

On 		1	2	
	I	On	On	100%
	II	On	-	75%
	III	-	On	50%
	IV	-	-	25%

The distances above refer to ceiling mount,
 Wall mount maximum mounting height is 2m.

Hold Time

On 		3	4	
	I	On	On	5s
	II	On	-	90s
	III	-	On	5min
	IV	-	-	15min

Refers to the time period the lamp remains at 100% illumination after no motion detected.

Daylight Sensor

I: 2lux
 (darkness operation only)
 II: 10lux
 (Darkness operation only)
 III: 25lux
 (twilight operation)
 IV: 50lux
 (twilight operation only)
 V: Disable*
 (darkness operation only)

On 		5	6	
	I	On	On	Disable
	II	On	-	5Lux
	III	-	On	15Lux
	IV	-	-	50Lux

*When set to Disable mode, the daylight sensor will switch on the lamp when motion is detected regardless of ambient light levels.

Microwave dim version stand-by Period only

On 		7	8	
	I	On	On	0 Sec
	II	On	-	5min
	III	-	On	30min
	IV	-	-	

Refers to the stand-by time period the lamp remains at the set dim level of illumination after no motion detected.
 (20% Default or 10%/25%/50% using remote control LEV71931)

Factory default settings:
 Detection area: 100%
 Hold time: 5 seconds
 Stand-by period: 0 secs(MW Dim only)
 Daylight Sensor: Disabled

Profile & Dimensions

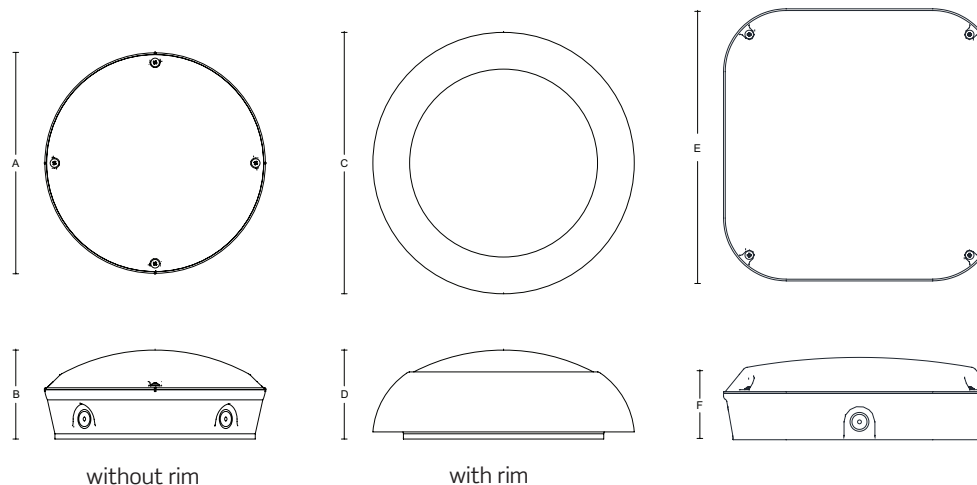

Shape	Wattage	A	B	C	D	E	F
Round	8/12W	Ø232.1	93.3	Ø274	93.3	N/A	N/A
Round	12W/16W/20W	Ø301	98.3	Ø340	98.3	N/A	N/A
Square	12W/16W/20W	N/A	N/A	N/A	N/A	286	87

All dimensions in millimetres

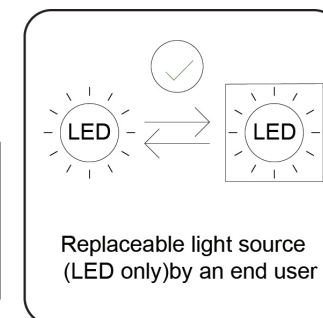
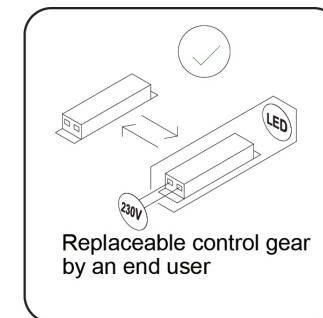

Emergency range routine inspection and test

All tests must be undertaken at times of least risk and in accordance with EN 50172:2004 as indicated below:

Weekly: Indicators of central power supply shall be visually inspected for correct operation.

Monthly: (in addition to the daily check) If automatic testing devices are used, the results of the short duration tests shall be recorded. Test shall be carried out as follows:

- a) Switch the luminaire over to emergency mode to operate from the batteries by simulating a failure of supply to the normal lighting for a period sufficient to ensure correct luminaire operation

NOTE: The period of simulation failure should be sufficient for the purpose of this clause whilst minimising damage to the system components e.g lamps. During this period, all luminaires and signs shall be checked to ensure that they are present, clean and functioning correctly. At the end of this test period, the supply to the normal lighting should be restored and any indicator lamp or device should be checked to ensure that is showing that the normal supply has been restored.

Annually: If automatic testing devices are used, the results of the short duration tests shall be recorded. For all other systems the monthly inspection shall be carried out and the following additional tests made:

- a) Each luminaire and internally illuminated sign shall be tested monthly as above but for its full duration in accordance with the manufacturer's information.
- b) The normal supply for the luminaire should be restored and any charge indicator lamp or device should be checked to ensure that it shows the normal supply has been restored. The charging arrangements should be checked for proper functioning.
- c) The date of the test and its results shall be recorded in the system logbook.

A copy of this report must accompany any fitting returned to the manufacturer for any reason.

General Information

Our products are designed to comply with the requirements of UK law and the relevant industry national and international standards and should not be modified in any way. All emergency lighting systems should comply with the recommendations of BS5266-1: Code of Practice for the Emergency Lighting of Premises and be installed by competent engineers in accordance with the relevant wiring regulations. Before installing any type of Emergency Lighting always seek the advice and approval of the local Fire Prevention Officer (or equivalent authority).

Maintenance

Failed or faulty light sources connected to this equipment should be replaced immediately. These units are designed especially for a long and trouble free life. Under normal conditions, will require no routine maintenance or service beyond the inspection and test regime of BS5266-1. Both mains supply and battery protection fusing is incorporated internally. Should access to these or any other part of the circuitry be required this must be undertaken only by suitably qualified person. Special care must be taken when removing the cover to circuitry and battery. Only replacement components authorised by the company must be used. Disposal of replaced components should be in accordance with the component manufacturers instructions.

You can help protect the environment. Please remember to respect the local regulations: hand in the non-working electrical equipment to an appropriate waste disposal centre. The packaging material is recyclable. Dispose of the packaging in an environmentally friendly manner and make it available for the recyclable material collection service.

Important warranty information

This product is supported by a 2-year standard warranty which will extend to 5-years if registered within the first year of purchase. (5 year on batteries). Please register at jcc.co.uk/warranty (Terms and conditions apply).

The installer will be asked to provide the following information, which is detailed on a label attached to the luminaire's chassis: Product Code/Date Code.

Emergency test record sheet

Month	Test Type	First Year		Second Year		Third Year		Fourth Year		Fifth Year	
		Sign	Date	Sign	Date	Sign	Date	Sign	Date	Sign	Date
January	Functional										
February	Functional										
March	Functional										
April	Functional										
May	Functional										
June	Functional										
July	Functional										
August	Functional										
September	Functional										
October	Functional										
November	Functional										
December	3 hour										



CE UK CA IP65 jcc.co.uk V4_September_2024_RS